

These instructions provide photographs of completed model, exploded view drawings, diagrams, step-by-step instructions and an itemized parts list. If for reasons beyond our control, any shortage or faulty part is found, write directly to the manufacturer, including name of your dealer and date of purchase. Return any defective parts for exchange.

The builder should study the instructions and drawings to attain a working knowledge of proper procedure. Assembly work should be in sequence outlined in this manual to assure proper construction.

We have included some extra parts in case you misplace or drop them on the floor.

DO NOT RUN THE MECHANISM OR ENGINE UPSIDE DOWN.

TOOLS

This is a builders kit, you will need a few tools. You will find use for the following: small hammer, several assorted pattern files, jewelers screwdriver (a set is convenient), a 6" flat file with a fairly fine cut, knife, pliers, flush cut nippers like Mascot #413 and tweezers.

BEFORE PAINTING YOUR MODEL OR DETAIL THE BOILER, WE RECOMMEND THAT YOU BUILD THE COMPLETE MECHANISM ATTACH THE UNDECORATED BODY AND THOROUGHLY TRACK TEST IT.

STEP #1

Clean flash from frames.

CLEAN ALL FLASH FROM EDGES OF BEARING SLOTS OF UNDERFRAME AND COVER PLATE. FILE MATING SURFACES ON A FLAT FILE. CHECK TO SEE THAT FRAMES ARE STRAIGHT.

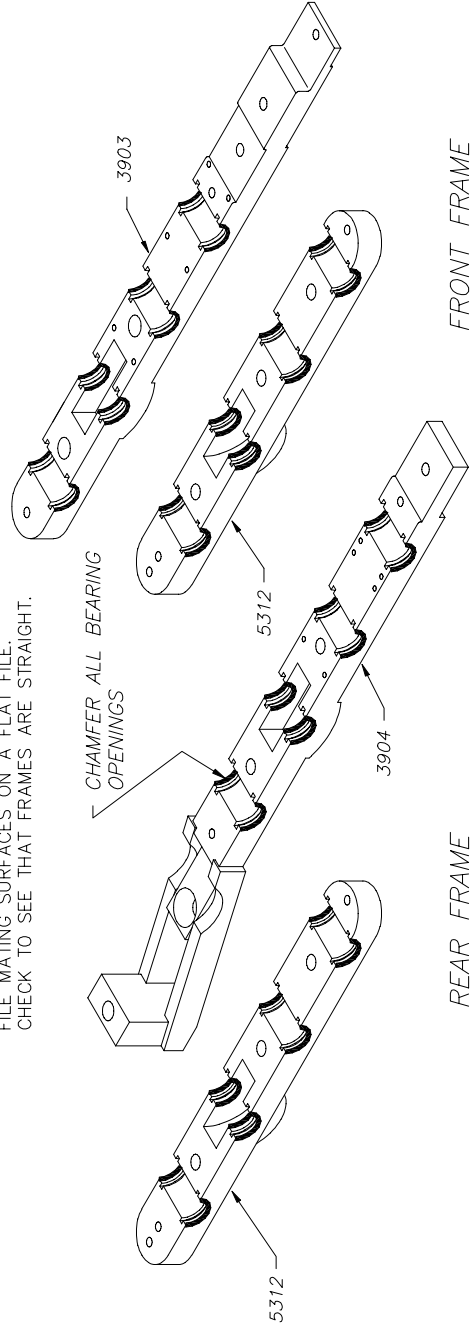

REAR FRAME









FRONT FRAME

STEP #2

Subkit 100353, 100304 & 100311

FULL SIZE

Clean flash from edges of parts. File mating surfaces on a flat file. Check to see that the frame is straight. Assemble the drivers with insulated wheels on the left side of the frame as shown. Assure the wheels spin freely. Oil lightly. See Step 3 for method of loosening wheels.

-  65007
-  65007
-  256053
-  256071
-  256073
-  875
-  27
-  256

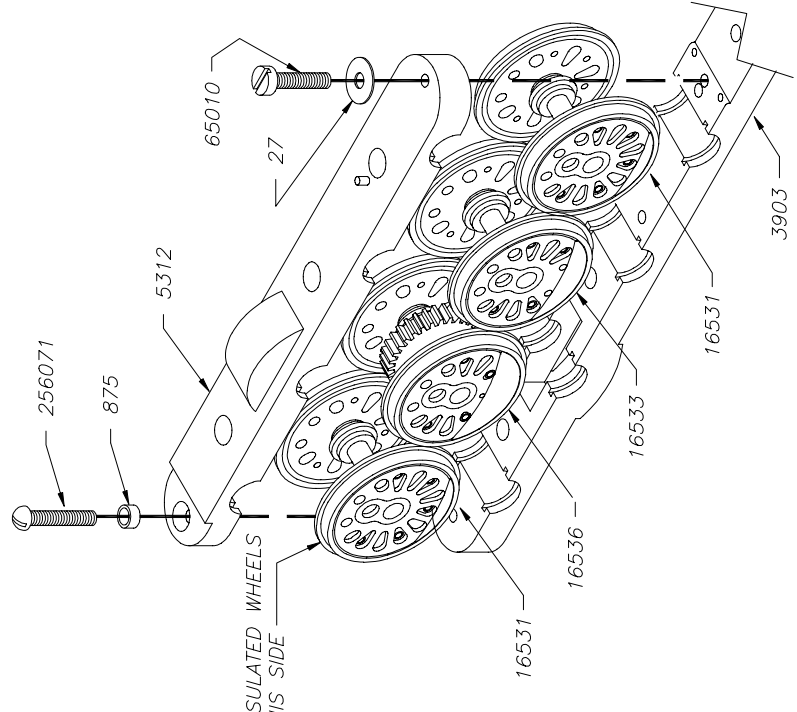
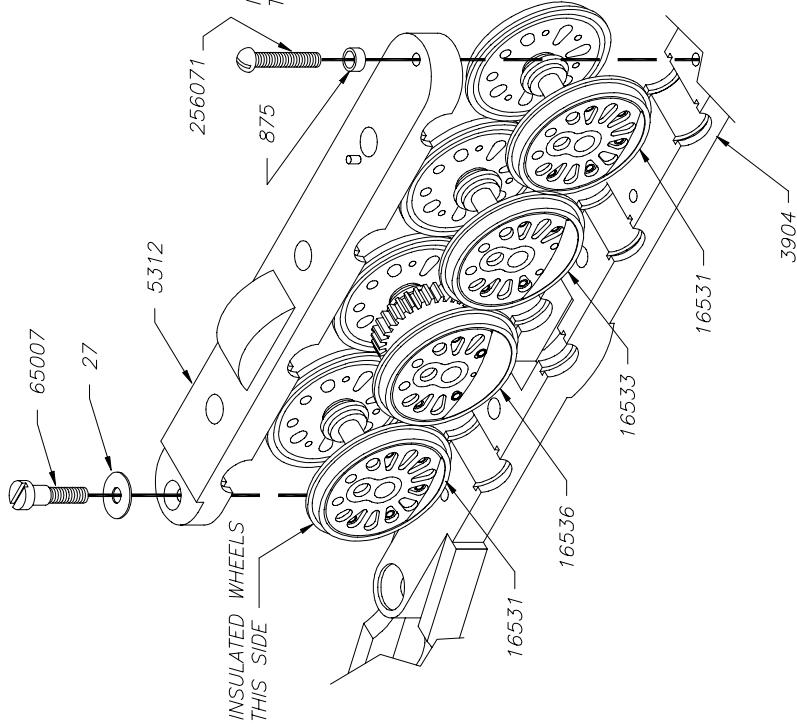

STEP #3

Assemble draw bar as shown.

TO SEAT BEARINGS, SUPPORT FRAME ON FINGERS, NOT A SOLID BLOCK. PLACE A 5/16 NUT OVER BEARINGS AND STRIKE A SHARP BLOW USING A TACK HAMMER OR OTHER LIGHT HAMMER. REPEAT OVER EACH AXLE UNTIL EACH DRIVER SPINS FREELY. DO NOT PROCEED ANY FURTHER UNTIL ALL DRIVERS WILL SPIN FREELY.

DO NOT FLATTEN SPRING BOSS

INSULATED DRIVERS ON THIS SIDE OF FRAME.

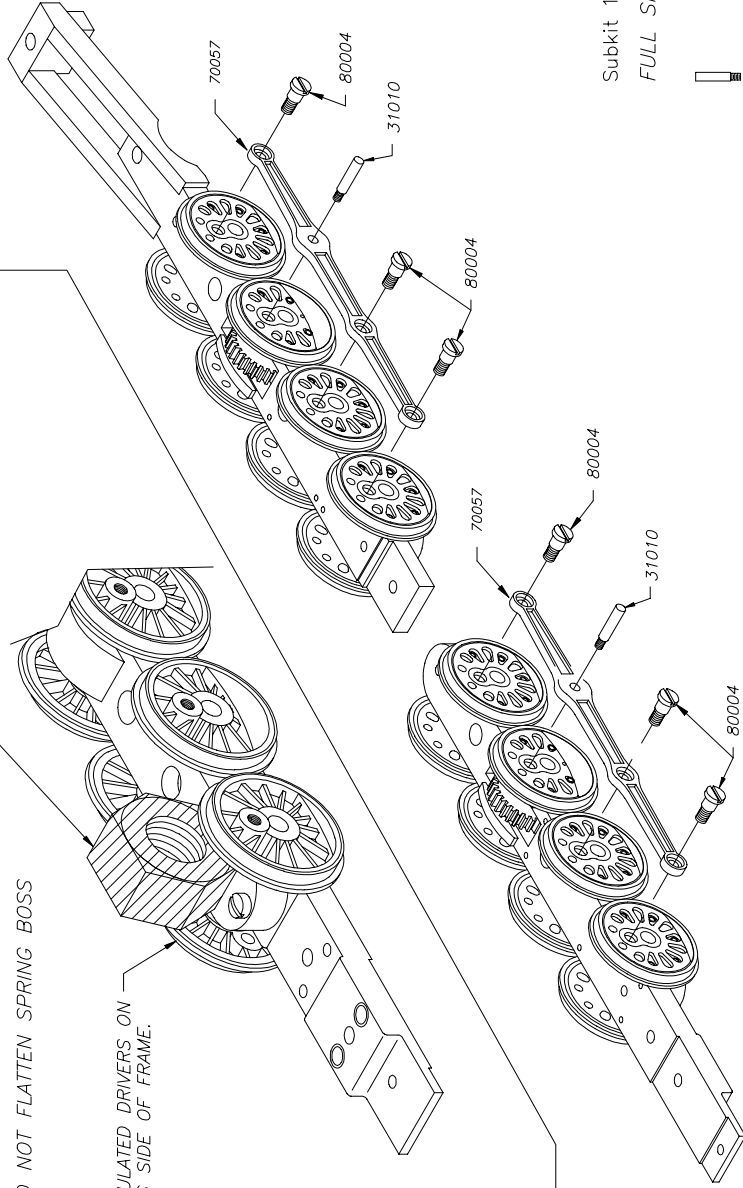

STEP #4

Assemble side rods to drivers.
Assure wheels spin freely.
If binding occurs ream holes
in side rods until eliminated.
Oil lightly.

WHEELS MUST SPIN ABSOLUTELY FREE.



STEP #4

Assemble cylinders & crosshead guides.

REMOVE RIVET DETAIL FROM SIDE OF CROSSHEAD GUIDES WHICH FACE FRAMES.

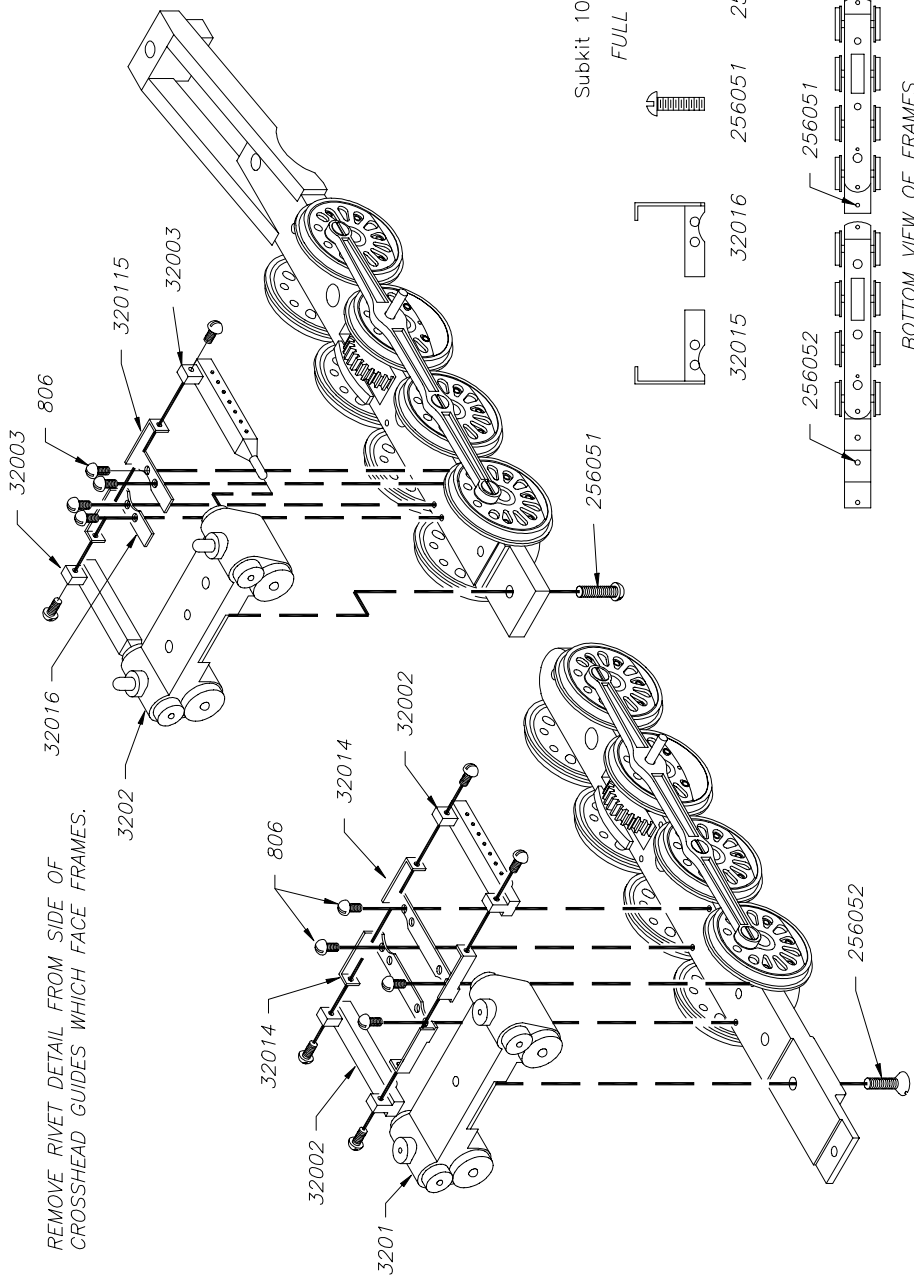

Subkit 100322, 100353

FULL SIZE

	32015	32016	256051	256052	806
--	-------	-------	--------	--------	-----

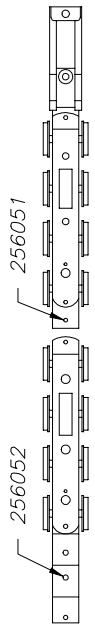

BOTTOM VIEW OF FRAMES

STEP #5

Install crossheads and main rods on both sides of both mechanisms.
Mechanism should roll without any binding.
Do not proceed further until all binding is removed.

Note: Put a drop of glue on threads only of 80006 to keep them from working out. Do not get glue on crossheads. They must be free to pivot.

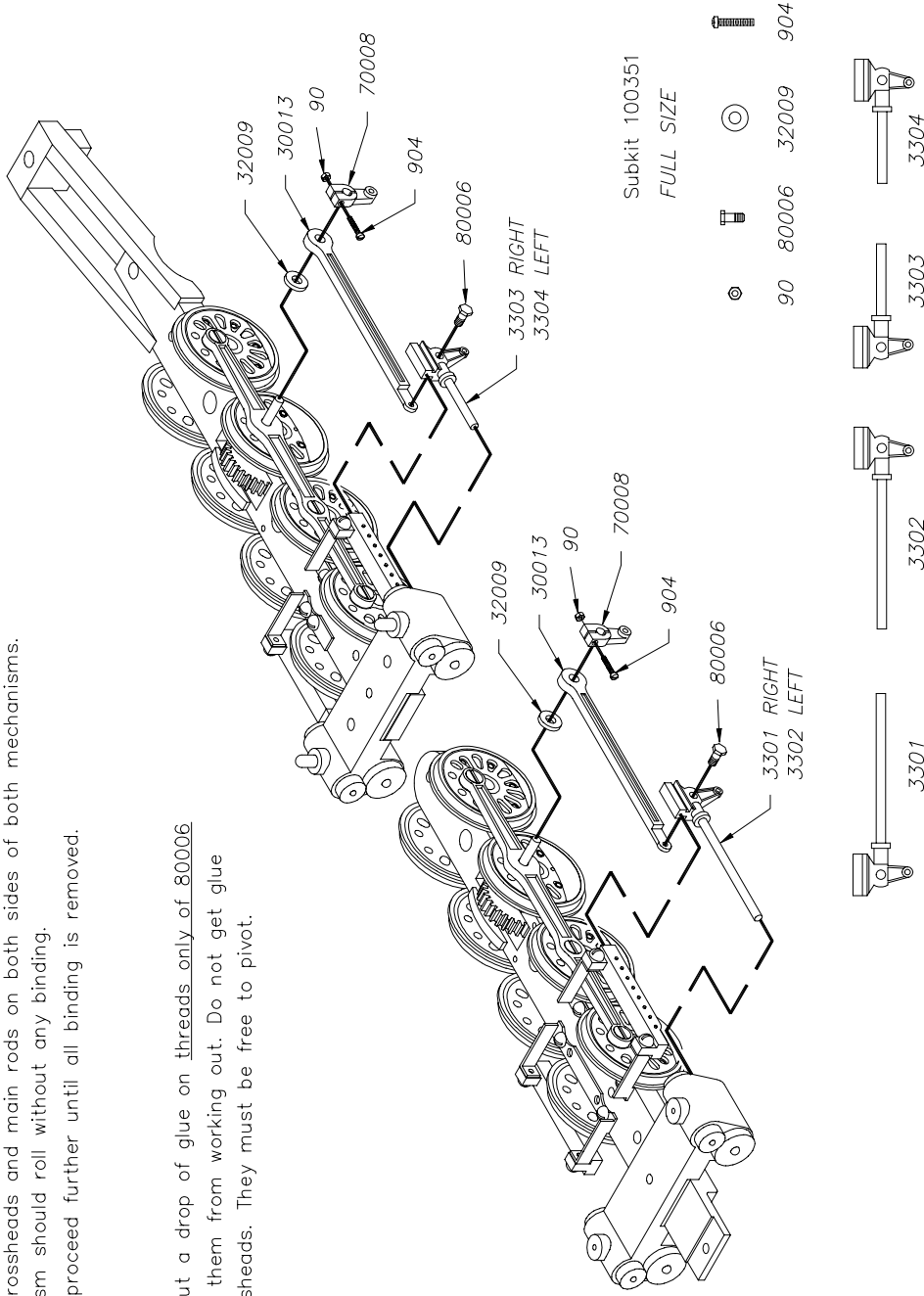

STEP #6

PARTS SHOWN FULL SIZE

- Assemble valve gear. Subkit 100355
- 31001
- 31002
- 31003
- 31004
- 31005
- 31006
- 31007
- 31008
- 60007
- 67010
- 80007

RIGHT FRONT

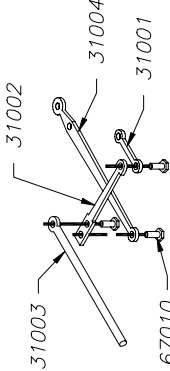

LEFT FRONT

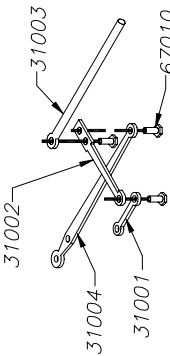

RIGHT REAR

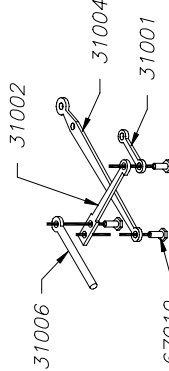

LEFT REAR

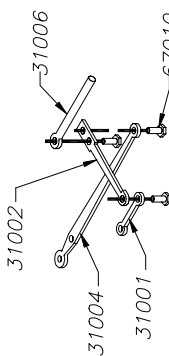

RIGHT SIDE

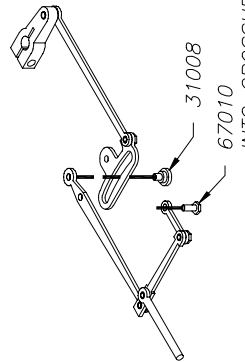

RIGHT SIDE

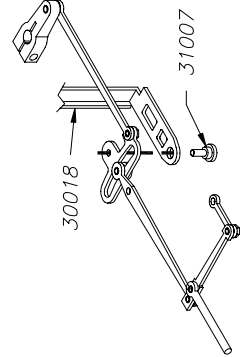

RIGHT SIDE

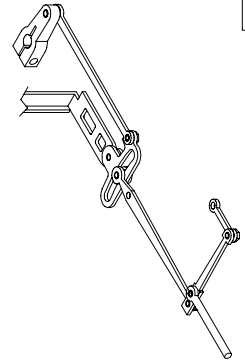

RIGHT SIDE MAKE (2)

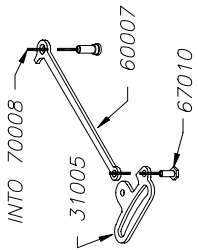

LEFT SIDE MAKE (2)

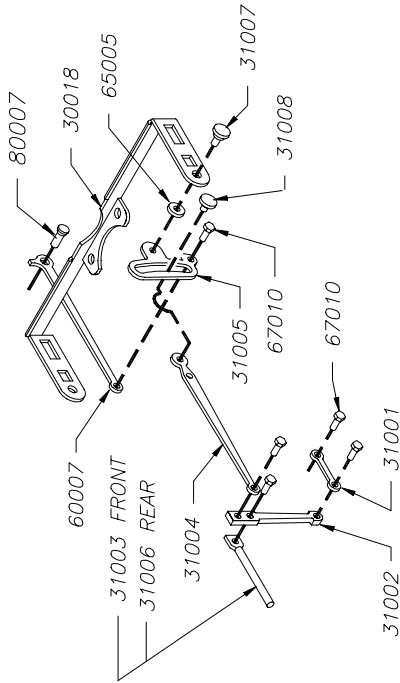
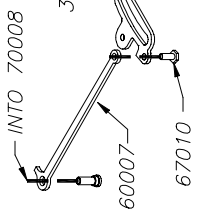

STEP #6A

Install valve gear.
Time valves as shown below.

Subkit 100355

FULL SIZE



806

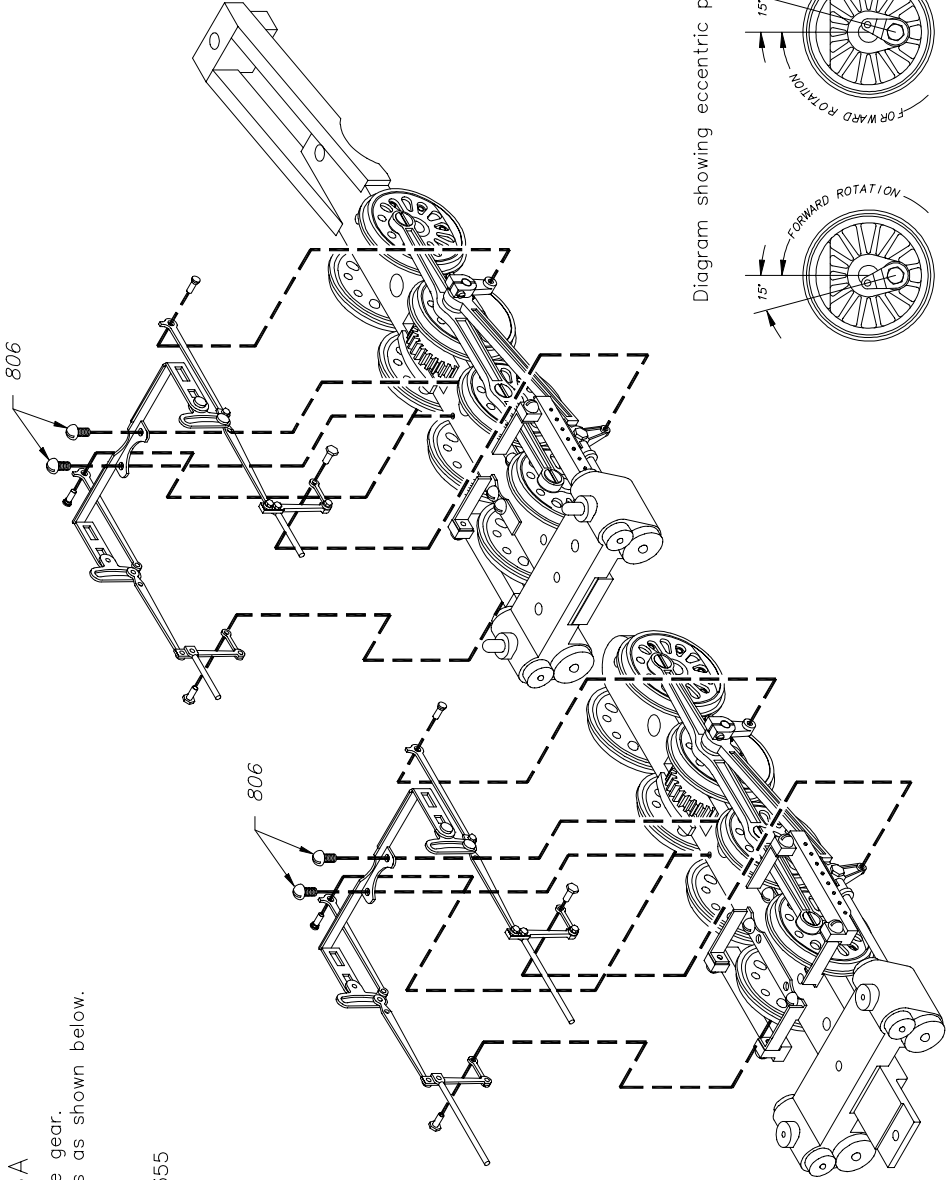
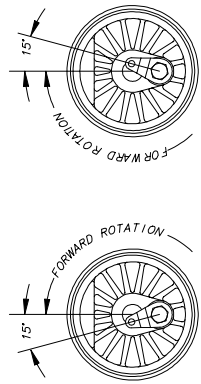

Diagram showing eccentric position



STEP #7

Install motor and drive line.
Couple both mechanisms together.

Subkit 100352, 100353

FULL SIZE

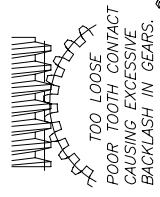
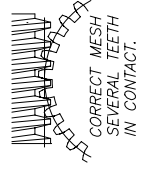
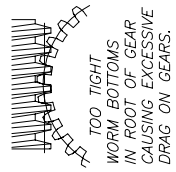

- 27
- 28
- 653
- 875
- 8451
- 256053
- 256071
- 256073

- 440032

- 30033
- 30034
- 30035
- 30036
- 902
- 8451
- 51105
- 903
- 28

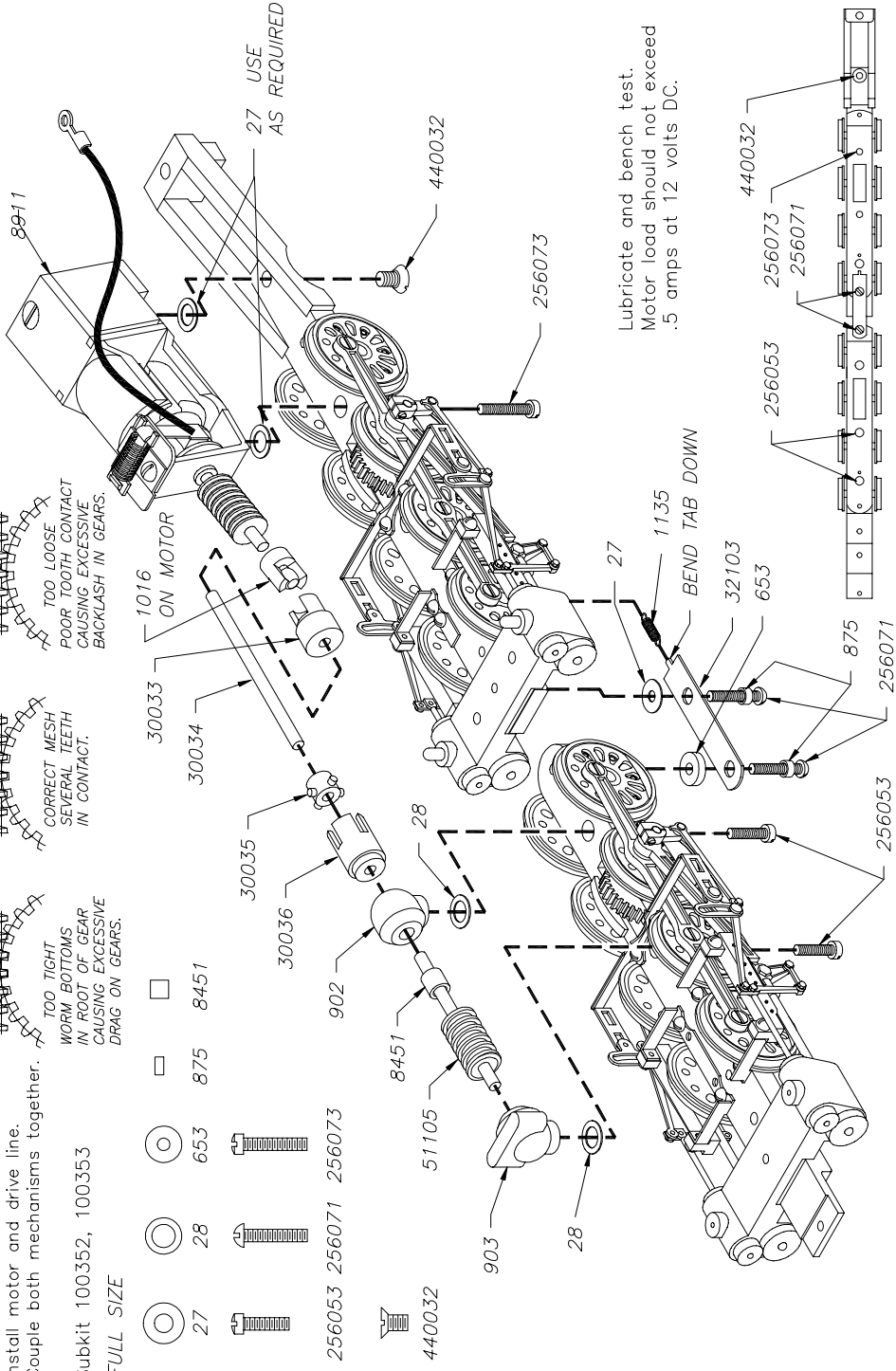

Lubricate and bench test.
Motor load should not exceed
.5 amps at 12 volts DC.

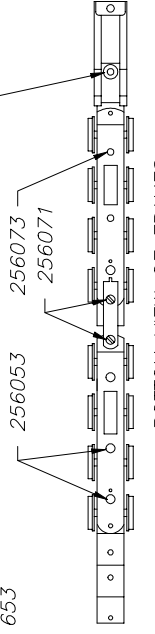

BOTTOM VIEW OF FRAMES

STEP #8

Install boiler back plate and mount boiler and track test.
Do not detail boiler until you have track tested you engine.

Subkit 100353, 100364

FULL SIZE



256053



256041



256032

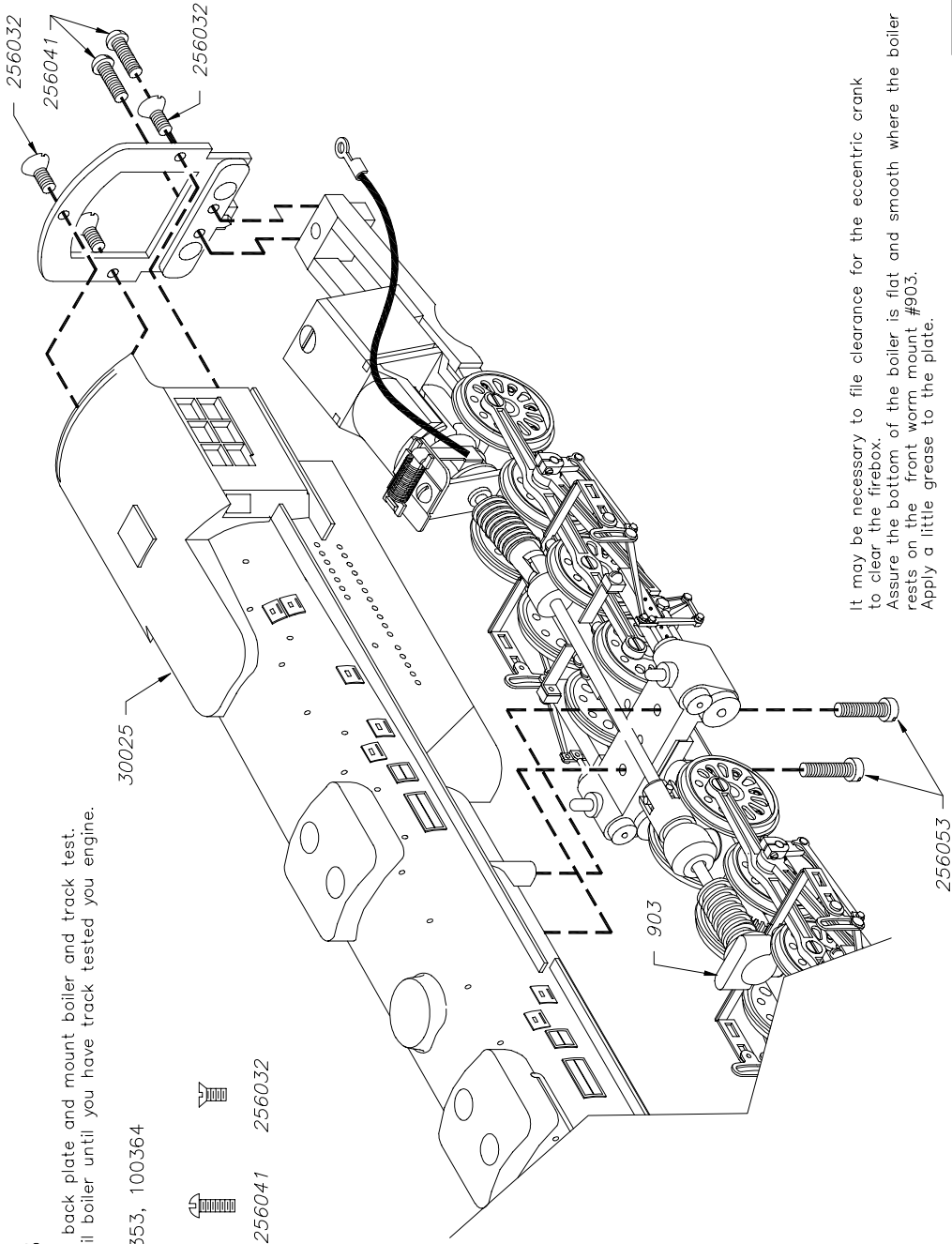

It may be necessary to file clearance for the eccentric crank to clear the firebox. Assure the bottom of the boiler is flat and smooth where the boiler rests on the front worm mount #903. Apply a little grease to the plate.

STEP #9

Assemble steam pipes to boiler.

Subkit 100353, 100356

FULL SIZE



80004

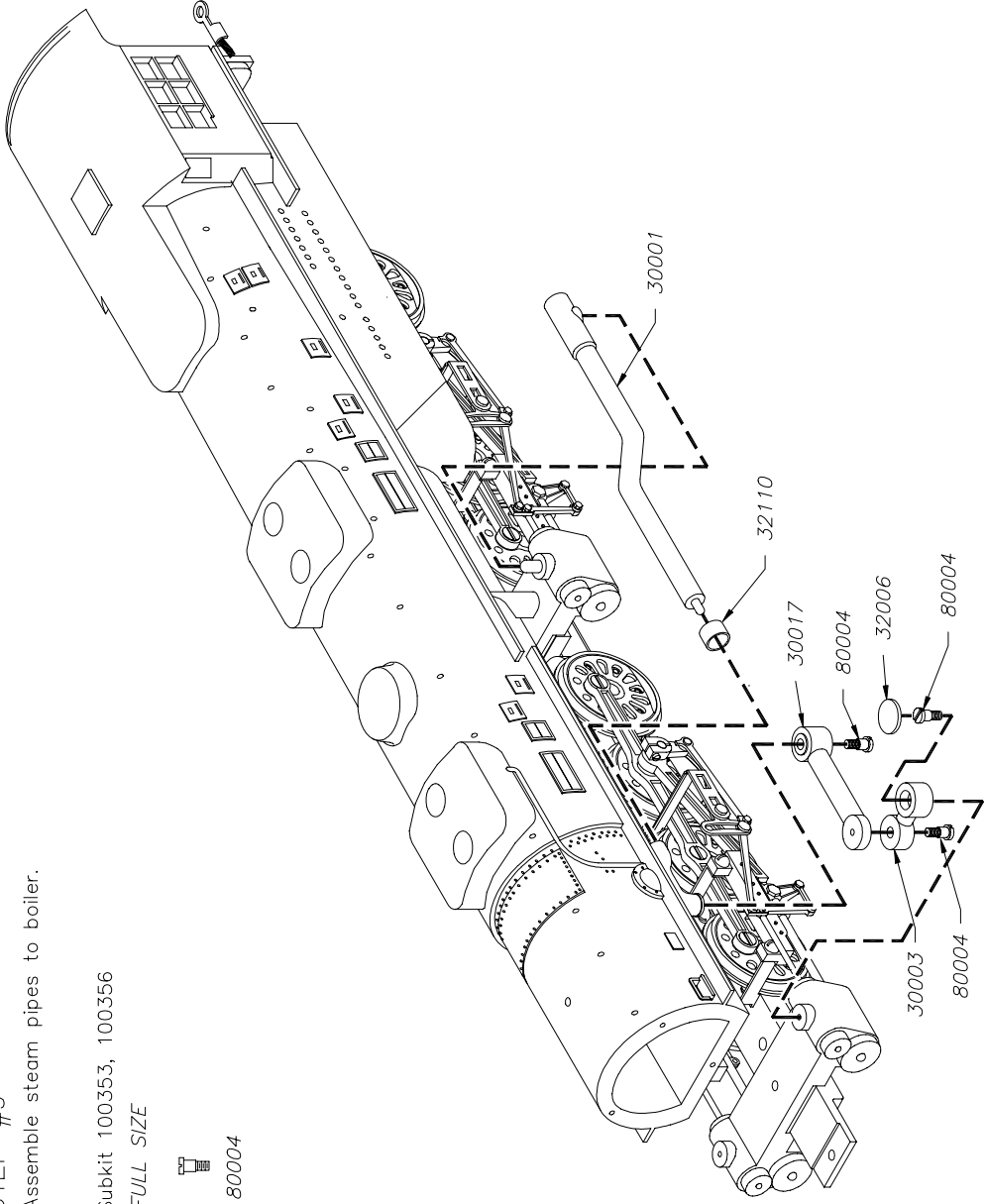

STEP #10

Assemble and install lead and trail trucks.

Subkit 100304, 100311

FULL SIZE



27



65010



65007

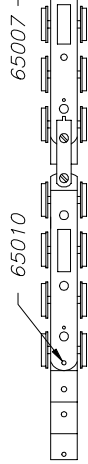
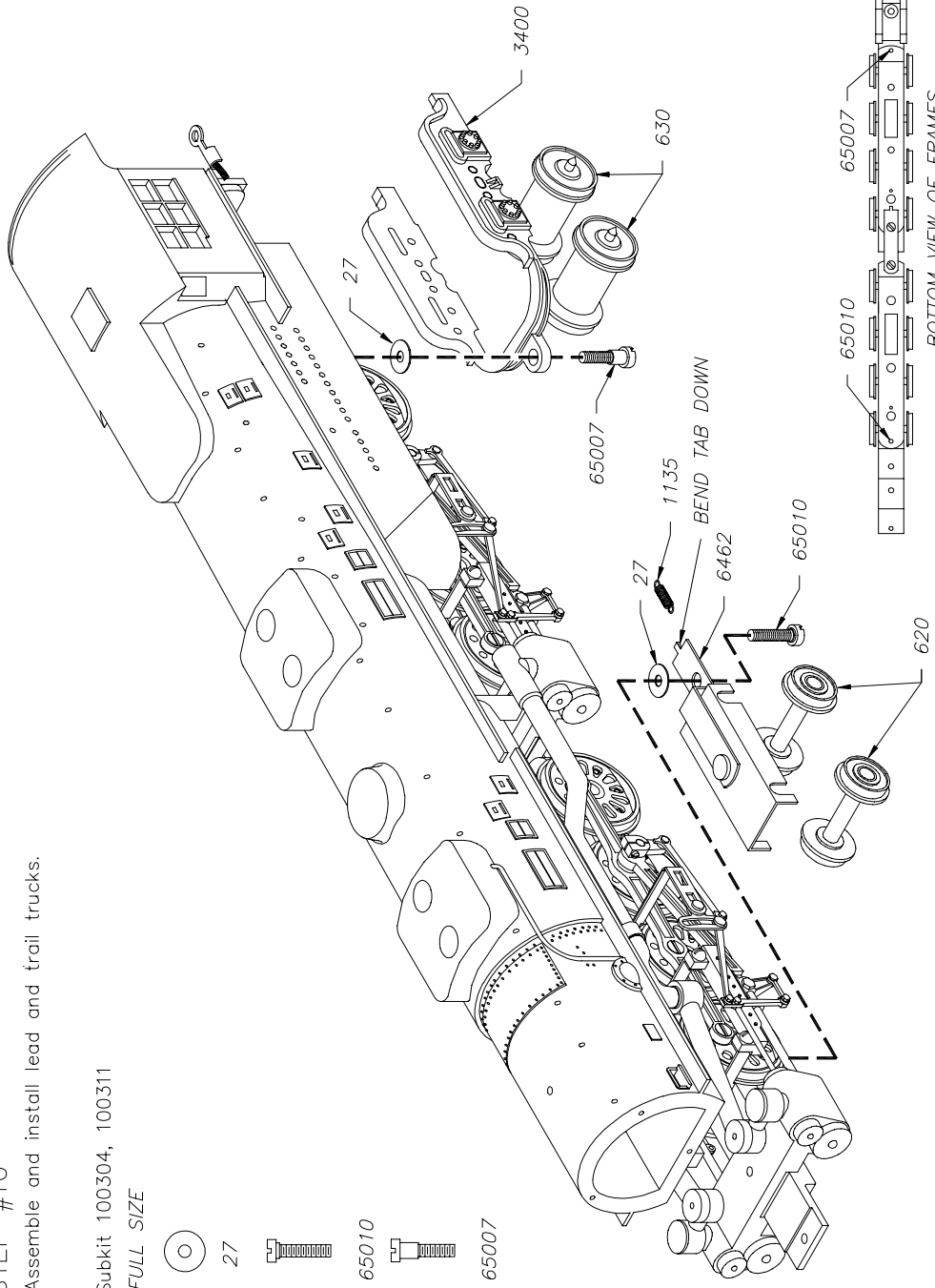

BOTTOM VIEW OF FRAMES

STEP #11

Assemble and install pilot.

Subkit 100364

FULL SIZE

- ⊙ 90
- ⌘ 904
- ⌘ 806

Rivet sub-assembly together

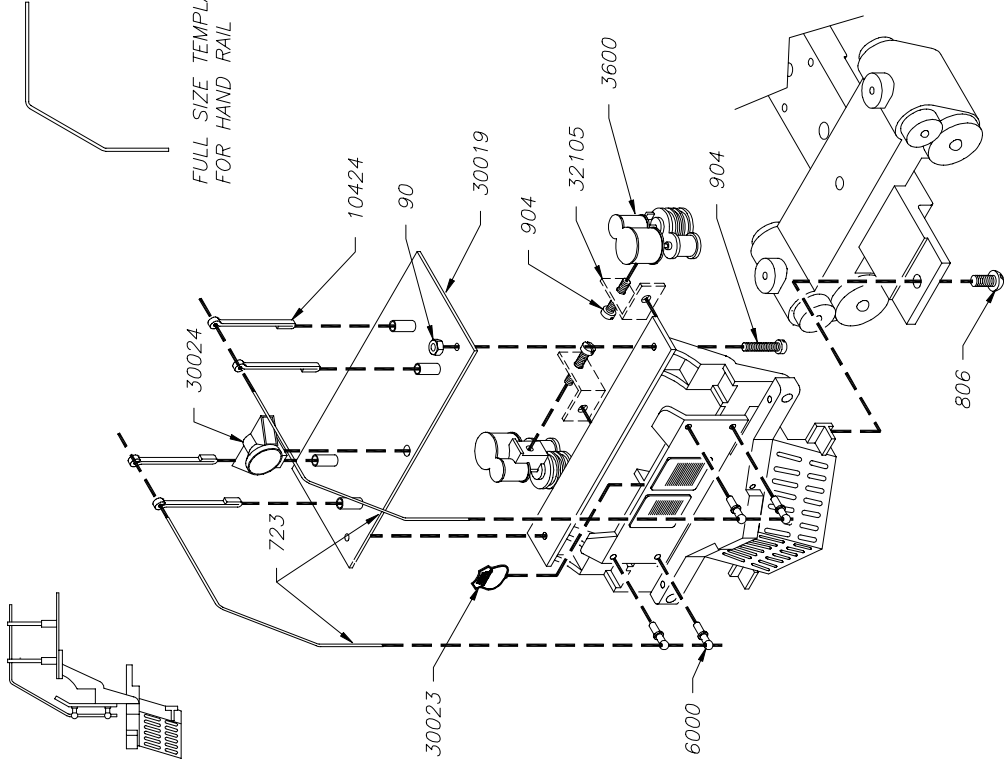
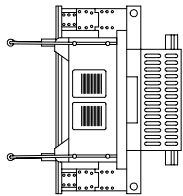
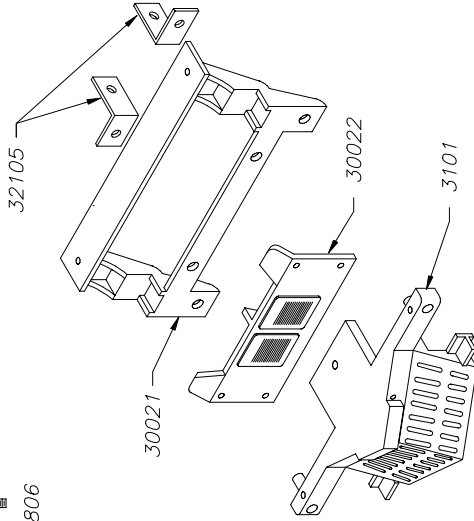

STEP #12
Detail boiler.

Subbit 100310, 100353, 100364
FULL SIZE

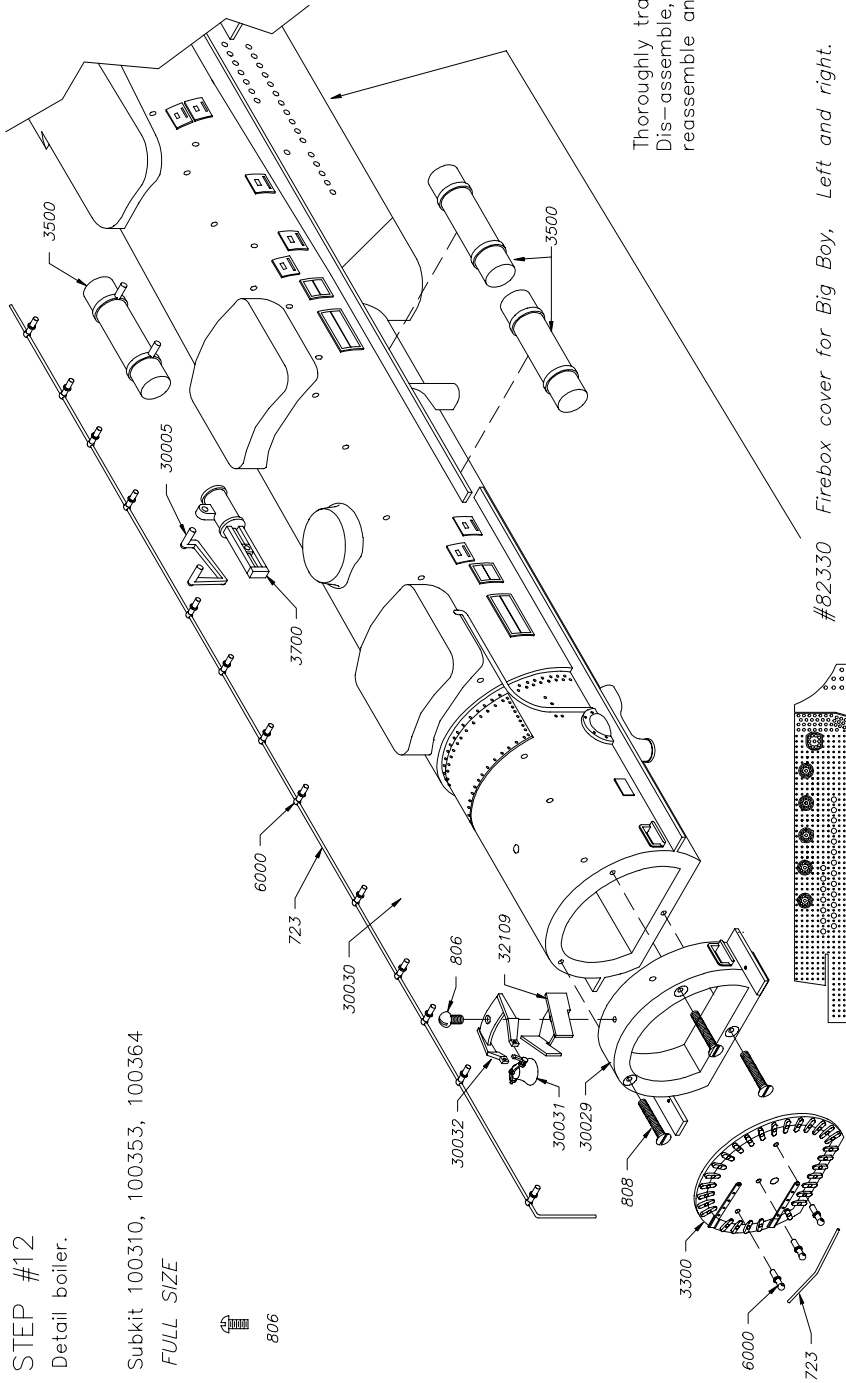

Thoroughly track test.
Dis-assemble, paint.
reassemble and ENJOY.

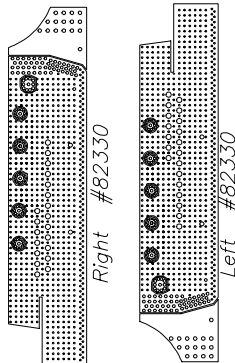

#82330 Firebox cover for Big Boy, Left and right.

To attach to the boiler:

1. File any large bumps on firebox.
2. Lay in place.
3. Form the front curve with your fingers.
4. Remove and complete the forming with your fingers
5. Glue in place. I recommend Goo or a 2 part epoxy.

Miscellaneous Building Tips

TIP 1: Painting Metal

You may want to superdetail your loco before painting.

We suggest that you do not paint your loco until it is thoroughly track tested as disassembly and handling generally ruins a paint job. Take your locomotive apart so that the various parts may be painted without getting paint on moving parts.

Valve gear, side rods, bearings, pony truck, etc. will not operate properly if paint gets into the joints of moving parts.

Parts to be painted should be degreased with a solvent like paint thinner and pickled in acetic acid solution (vinegar) or oxalic acid solution (5%) for a few minutes before applying paint.

DO NOT USE THIS VINEGAR FOR COOKING OR EATING.

Rinse with clean water. Do not handle the surfaces to

be painted. CAUTION: Do not immerse wheels, underframe or cover plate in acid solution or cleaners. Brush cleaner and acid solutions on metal frames of lead and trailing trucks and on underframe surfaces to be painted (NOT ON WHEELS, AXLES OR BEARING SLOTS). Drivers are pre-blackened and can be touched up, after removing flash, without using cleaner or acid. I recommend a glossy paint be used (PRR locos were painted Brunswick Green). Apply a smooth, uniform coat of good grade model railroad paint. I like to spray paint my models. Work carefully to avoid piling up paint around small details.

Painting exposed surfaces of main frame will add to final appearance of model, but be careful not to get paint in any bearings.

TIP 2: Hex Head Wrench (Cheap and Easy)

Go to your hardware store and buy Socket Head Cap Screws or Set Screws in many different sizes. They have the hex shape machined in the head and will work for tightening hex head screws.

TIP 3: Soldering Tips

Wear Eye Protection

First be sure everything is clean.

Put flux on both parts. Hold together and place solder iron at joint. The solder will flow to the hot area. Solder should not form a ball. This indicates the area was not hot enough. To tin your soldering iron so that solder will stick to it.

When cold clean the tip with a file. Put a little flux on tip. Turn on iron and apply solder to the tip as soon as it gets hot.

If this does not work. Clean the tip while hot and dip tip in a drop of flux (while hot) and immediately put solder on tip.

TIP 4: Cleaning A File When the Grooves Fill

When filing parts, the grooves in a file will fill with the metal you are filing.

This metal can be removed quickly by using a small piece of thin steel (1/16 to 1/8" thick) and sliding the steel on the file in the direction of the grooves. The chips that remain can be removed by sliding a sharp knife in each groove. This may take awhile to clean each groove. I do this only as a last resort. To keep most of the chips from sticking while you file, apply a thin oil to the file before filing.

TIP 5: Drilling Small Holes

To drill metal with small drills it is best to use powered tools. Dremel tool or a small drill press. Hand drilling with a pin vise will work but is much slower. You must drill straight. Drills do not bend they break. Use a lubricant on the drill. Cutting oil is best, but you can use a bar of Ivory Soap. Put the lube on the drill before starting. I recommend peck drilling.

(Drill about 1 or 2 times the diameter of the drill and remove the drill from the hole. Clean off the chips. Lube the drill and repeat.)

Take your time. It is very important to clean the chips from the flutes of the drill. When the flutes fill with chips the drill will break.

The smaller the drill the more you need to peck drill.

TIP 6: Tapping a Drilled Hole

First be sure your hole is the proper size.

00-90 Taps #60

0-80 Taps #55

2-56 Tap #49

4-40 Tap #43

These drill sizes are one size larger than the charts.

We feel they work very well for steel, brass and zinc.

You must tap straight. Taps do not bend they break.

Use a lubricant on the tap. Cutting oil is best but you can use a bar of Ivory Soap.

Put the lube on the tap before starting.

Turn in tap to get it started (1 or 2 turns). Back off 1/2 turn. This breaks the chips that form when tapping.

Repeat above. As the hole gets deeper you will have to back off the tap more often. If you are tapping a very deep hole you will have to back off the tap after as little as 1/2 turn